

Standard T5 Series

## LED T5 Linkable



Beam angle  
110°/130°



Core

## LED PC TUBE KIT



Beam angle  
130°



### Model Options:

- Linkable: Extendable design, could connect up to 8-10 tube lights together with seamless connectors ;
- Wide Application: This 2 foot LED light is perfect for various lighting needs. It is ideal for daily lighting and applications in garages, workshops, basements, warehouses, workbenches, homes, barns, offices, attics, storage rooms, exhibition areas etc., any indoor lighting.

### Diagram:

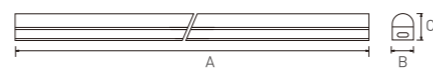

| T5 Serie   |                  |       |        |     |              |
|------------|------------------|-------|--------|-----|--------------|
| Power      | 4/9/13/18/22W    | Power | Lumen  | PF  | Dimension    |
| Voltage    | AC 220-240V      | 4W    | 340lm  | 0.5 | 289x22x30mm  |
| Efficiency | 100lm/w          | 9W    | 680lm  | 0.5 | 550x22x30mm  |
| ERP        | Y                | 13W   | 1260lm | 0.5 | 849x22x30mm  |
| EMC        | Y                | 18W   | 1440lm | 0.7 | 1149x22x30mm |
| CTT        | 3000/4000K/6500K | 22W   | 1620lm | 0.7 | 1449x22x30mm |
| Material   | PC               |       |        |     |              |



### Model Options:

- There are two ways to install it. One is using a bracket, and the other is using a hook for easy hanging.



| PC Tube    |                  |
|------------|------------------|
| Power      | 4/8/14/16/18W    |
| Voltage    | AC 220-240V      |
| Efficiency | 900lm            |
| CTT        | 3000/4000K/6000K |
| Material   | PP/PC            |
| Dimension  | 600x28x28mm      |



Standard

## LED Colorful Splicing Lamp



Beam angle  
110°/130°



### Features:

- This small panel has 6 or 12 independent modules. You can assemble them into any shape you want. It's powered by low voltage for flexible placement, perfect for TV backgrounds or gaming decor.

### Model Options:

- ON/OFF ;
- Remote control: Color temperature setting, Brightness setting, RGB Change
- RGB+W
- Wi-Fi, Bluetooth
- By adding tuya smart module, this ceiling light can connect to your phone.

|            |                    |
|------------|--------------------|
| Power      | 1Wx6pcs ; 1Wx12pcs |
| Voltage    | DC 24V 0.5A        |
| Efficiency | 100lm/w            |
| CTT        | RGB                |
| Material   | PP+PC              |
| Dimension  | 118x118x14mm       |

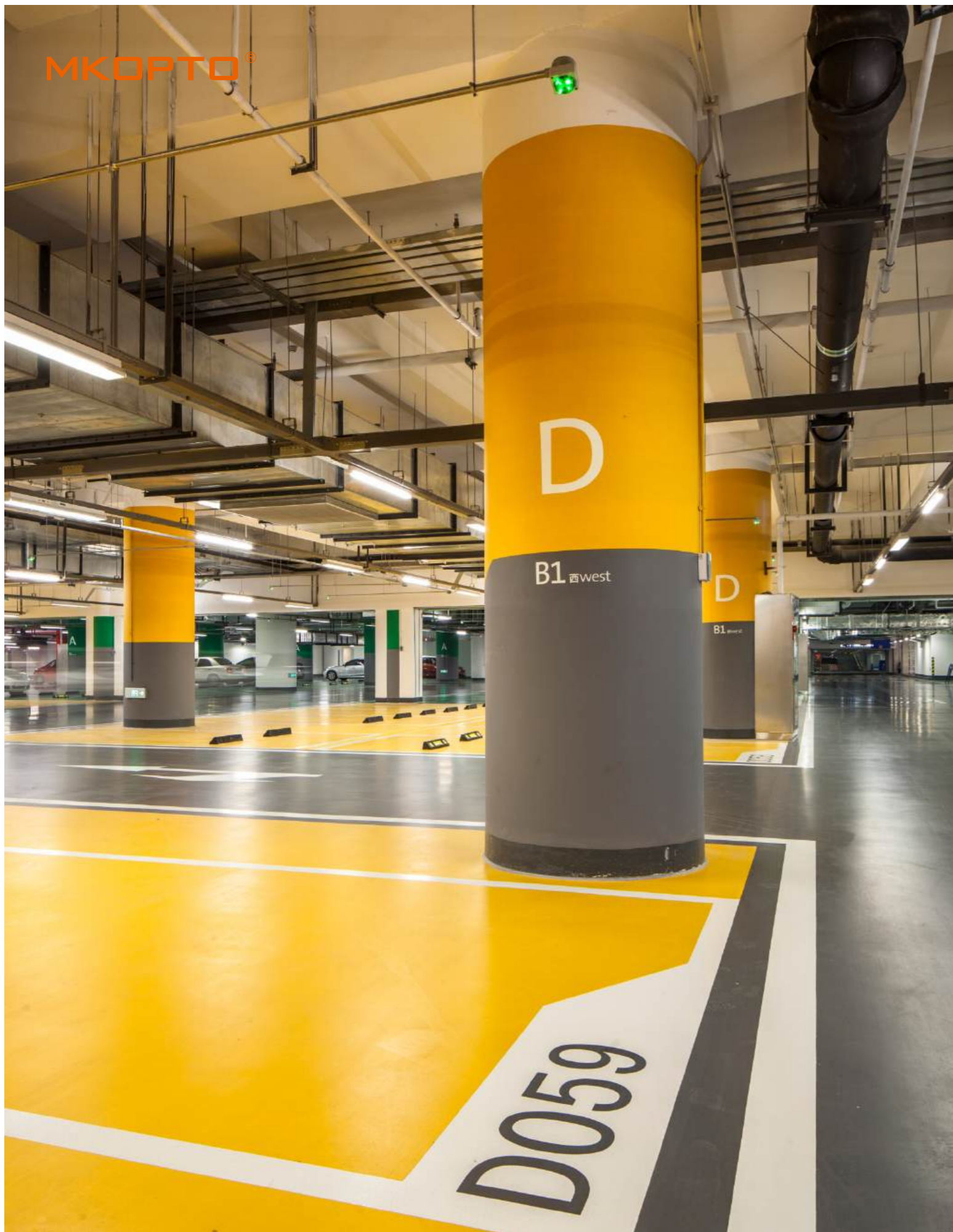

**Premium** TP05 Series

Waterproof · Dustproof · Antiseptic

## LED Tri-proof Light

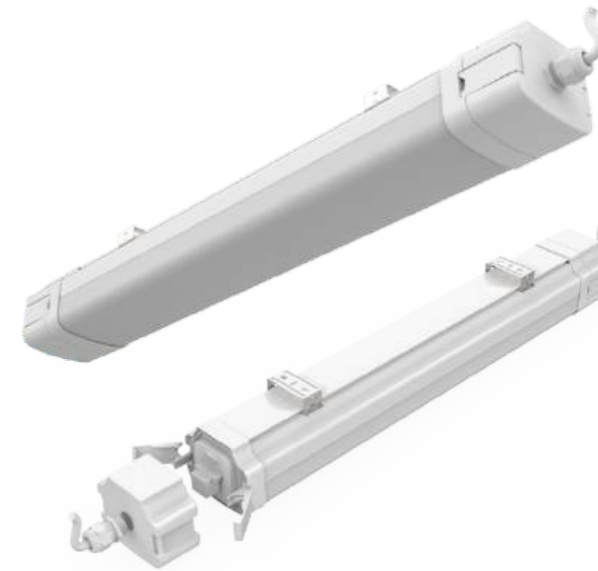

**3**  
YEARS  
WARRANTY

Beam angle  
120°

**160**  
lm/w

SMD

**185**  
lm/w

-20°C  
+40°C

IP65

30000h

CRI  
≥80

PF  
>0.7/0.9

IK10



Direct connection  
between three - proof lights



### Features:

- APPLICATION: Supermarkets, plaza, shopping malls · Basement/garage parking, workshops · indoor & Outdoor lighting ;
- IP65 Outdoor Rated, long Life Leds , water, insect And Dust Proof ;
- PC Cover with push fit terminal inside and tooling free connection ;
- Supporting linkable connection.

### Diagram:



| SS1 Serie  |                       |        |     |                  |
|------------|-----------------------|--------|-----|------------------|
| Power      | 18/36/48/60/80W       | Power  | PF  | Dimension        |
| Voltage    | 185-265V              | 18W    | 0.7 | 616.2x69x81.1mm  |
| Efficiency | 125/135/160/185lm/w   | 36W    | 0.9 | 1216.2x69x81.1mm |
| CCT        | 3000/4000K/6500K      | 48W    | 0.9 | 1516.2x69x81.1mm |
| Material   | PC                    | 60/80W | 0.7 | 1816.2x69x81.1mm |
| Function   | Switch CCT, Microwave |        |     |                  |

# LED Tri-proof Light



CCT Adjustable & Brightness dimming



3 YEARS WARRANTY

160 lm/w

185 lm/w

IP65

CRI ≥80

Beam angle 120°

SMD

-20°C +40°C

30000h

PF >0.7/0.9

IK08



## Functions:

- Switch Power (50%-75%-100%)
- Switch CCT (3000K, 4000K or 6500K)
- Microwave Sensor Optional

## Features:

- Flickering Free (THD<10%);
- Linkable;
- Easy Installation.

## Diagram:

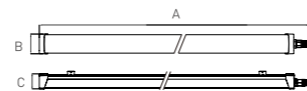

| SE1 Serise |                                       |        |         |              |
|------------|---------------------------------------|--------|---------|--------------|
| Power      | 18/36/48W                             | Power  | PF      | Dimension    |
| Voltage    | AC 220-240V                           | 18/30W | 0.7/0.9 | 576x64x58mm  |
| Efficiency | 120/135/160/185lm/w                   | 36/60W | 0.7/0.9 | 1176x64x58mm |
| CCT        | 3000/4000K/6500K                      | 48/80W | 0.7/0.9 | 1476x64x58mm |
| Cable      | 37cm H05RN-F 3G*1.0mm <sup>2</sup>    |        |         |              |
| Surge      | 1KV/0.5KV                             |        |         |              |
| Material   | PC+PC                                 |        |         |              |
| Function   | Toggle DIM, CCT adjustable, Microwave |        |         |              |

# LED Tri-proof Light

3 YEARS WARRANTY

160 lm/w

185 lm/w

IP65

CRI ≥80

Beam angle 120°

SMD

-20°C +40°C

30000h

PF >0.7/0.9

IK08



## Features:

- This three-proof lamp is available in models with relatively high wattages, which can easily meet the stringent requirements for high-brightness lighting in various scenarios. Whether it is in industrial workshops, underground parking lots, or outdoor warehouses, it can create a safe and clear environment with its sufficient light. ;
- This three-proof lamp is available in a quick-connect version and a direct wire-out version. Among them, only the quick-connect version supports the daisy-chaining function, which can meet diverse installation requirements.

## Diagram:



| SE2 Serise |                     |       |         |              |
|------------|---------------------|-------|---------|--------------|
| Power      | 30/60/80W           | Power | PF      | Dimension    |
| Voltage    | 100-265V/185-265V   | 30W   | 0.7/0.9 | 576x64x58mm  |
| Efficiency | 110/135/160/185lm/w | 60W   | 0.7/0.9 | 1176x64x58mm |
| CCT        | 3000/4000K/6500K    | 80W   | 0.7/0.9 | 1476x64x58mm |
| Material   | PP+PC               |       |         |              |

Standard

TP04 Series

Waterproof · Dustproof · Antiseptic

## LED Tri-proof Light

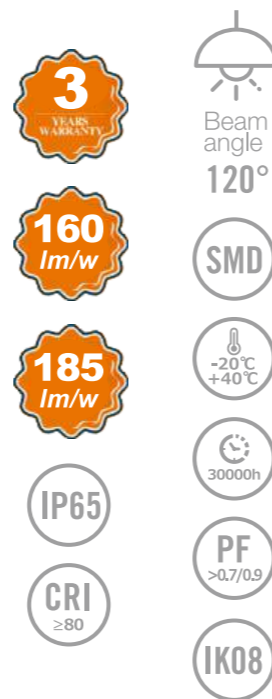

Fast connector



### Features:

- APPLICATION: Supermarkets, plaza, shopping malls · Basement/garage parking, workshops · indoor & Outdoor lighting ;
- IP65 Outdoor Rated, long Life Leds , water, insect And Dust Proof ;
- PC Cover with push fit terminal inside and tooling free connection ;
- Supporting linkable connection.

### Diagram:

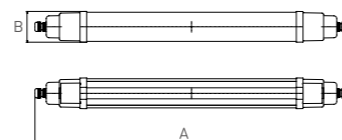

| SC3 Serise |                     | Power | PF  | Dimension     |
|------------|---------------------|-------|-----|---------------|
| Power      | 18/36/48W           | 18W   | 0.7 | 666.2x65.5mm  |
| Voltage    | 185-265V            | 36W   | 0.9 | 1266.2x65.5mm |
| Efficiency | 125/135/160/185lm/w | 48W   | 0.9 | 1566.2x65.5mm |
| CCT        | 3000/4000K/6500K    |       |     |               |
| Material   | PC+PP               |       |     |               |

Standard

TP03 Series

Waterproof · Dustproof · Antiseptic

## LED Tri-proof Light



### Features:

- APPLICATION: Supermarkets, plaza, shopping malls · Basement/garage parking, workshops · indoor & Outdoor lighting ;
- IP65 Outdoor Rated, long Life Leds , water, insect And Dust Proof ;
- PC Cover with push fit terminal inside and tooling free connection ;
- Supporting linkable connection.

### Diagram:

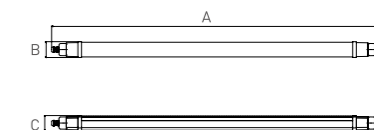

| SC2 Serise |                       | Power | PF  | Dimension     |
|------------|-----------------------|-------|-----|---------------|
| Power      | 18/36/48W             | 18W   | 0.7 | 676.6x58.8mm  |
| Voltage    | 185-265V              | 36W   | 0.9 | 1276.6x58.8mm |
| Efficiency | 125/135/160/185lm/w   | 48W   | 0.9 | 1576.6x58.8mm |
| CCT        | 3000/4000K/6500K      |       |     |               |
| Material   | PC+PP                 |       |     |               |
| Function   | Switch CCT, Microwave |       |     |               |

# LED Tri-proof Light



- 3 YEARS WARRANTY
- 160 lm/w
- 185 lm/w
- IP65
- CRI ≥80
- Beam angle 120°
- SMD
- 20°C +40°C
- 30000h
- PF >0.7/0.9
- IK08



## Features:

- APPLICATION: Supermarkets, plaza, shopping malls · Basement/garage parking, workshops · indoor & Outdoor lighting ;
- IP65 Outdoor Rated, long Life Leds , water, insect And Dust Proof ;
- PC Cover with push fit terminal inside ;
- Supporting linkable connection.

## Diagram:



| TP02 Serise |                     |       |     |                    |
|-------------|---------------------|-------|-----|--------------------|
| Power       | 18/36/48W           | Power | PF  | Dimension          |
| Voltage     | 185-265V            | 18W   | 0.7 | 656.7X78.9X41.6mm  |
| Efficiency  | 120/135/160/185lm/w | 36W   | 0.9 | 1256.7x78.9x41.6mm |
| CCT         | 3000/4000K/6500K    | 48W   | 0.9 | 1556.7x78.9x41.6mm |
| Material    | PC                  |       |     |                    |

# LED Tri-proof Light



- 3 YEARS WARRANTY
- IP65
- CRI ≥80
- PF >0.7/0.9
- IK08
- Beam angle 120°
- SMD
- 20°C +40°C
- 30000h



## Features:

- APPLICATION: Supermarkets, plaza, shopping malls · Basement/garage parking, workshops · indoor & Outdoor lighting ;
- IP65 Outdoor Rated, long Life Leds , water, insect And Dust Proof ;
- PC Cover with slim designs with faster connector inside.

## Diagram:

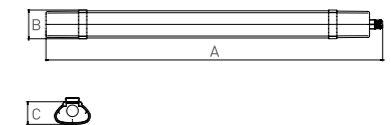

| TP01 Serise |                   |       |     |                    |
|-------------|-------------------|-------|-----|--------------------|
| Power       | 18/36/48W         | Power | PF  | Dimension          |
| Voltage     | 100-265V/185-265V | 18W   | 0.7 | 618.5x52.8x33.8mm  |
| Efficiency  | 120lm/w           | 36W   | 0.9 | 1218.5x52.8x33.8mm |
| CCT         | 3000/4000K/6500K  | 48W   | 0.9 | 1518.5x52.8x33.8mm |
| Material    | PC                |       |     |                    |

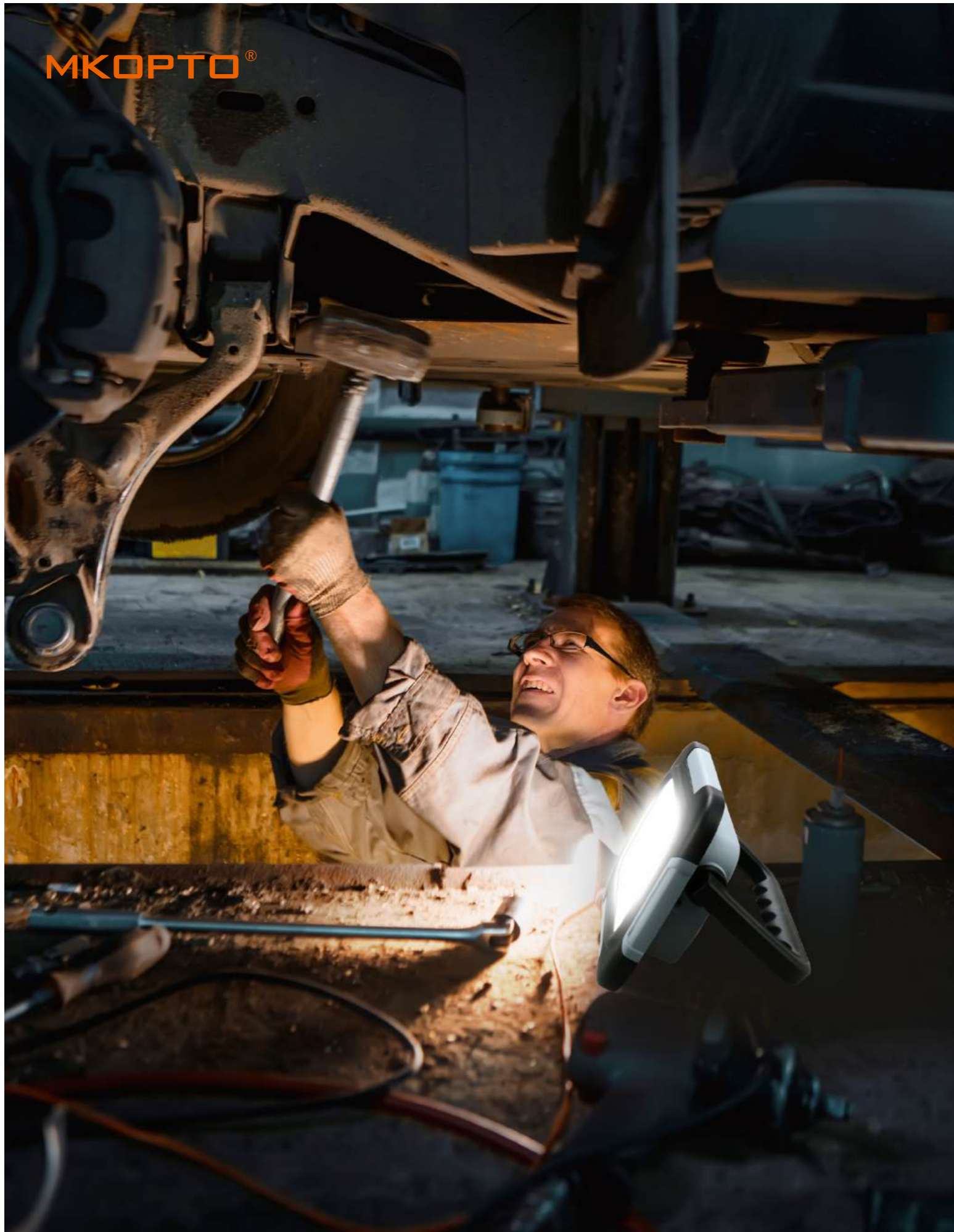

Type I A

## LED Worklight



Beam angle  
120°



### Features:

- Brightness dimming with one button at backside, 100%-50%-off;
- Available to DIY color of the handle and frame;
- Support to add the magnetic function.

### Diagram:

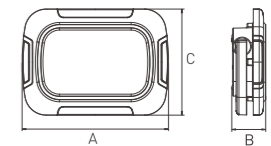

| Type I A      |                                |                                |                                |
|---------------|--------------------------------|--------------------------------|--------------------------------|
| Power         | 10W                            | 15W                            | 20W                            |
| Battery       | 3.7V 4000mAh 18650 Li-ion 2pcs | 3.7V 5200mAh 18650 Li-ion 2pcs | 3.7V 7200mAh 18650 Li-ion 4pcs |
| USB Out       | 5V 1A                          | 5V 1A                          | 5V 2A                          |
| Charging Time | 5H                             | 5H                             | 5H                             |
| Working Time  | 3H                             | 3H                             | 3H                             |
| CCT           | 3000/4000K/6500K               | 3000/4000K/6500K               | 3000/4000K/6500K               |
| Material      | Plastic                        | Plastic                        | Plastic                        |
| Function      | DIM 100%-50%-off / SOS         | DIM 100%-50%-off / SOS         | DIM 100%-50%-off / SOS         |
| Dimension     | 175x43x125mm                   | 175x43x125mm                   | 175x53x125mm                   |

Type I B

## LED Worklight



Beam angle  
120°

IP54

SMD

CRI  
>80

-20°C  
+40°C

PF  
>0.5

25000h



### Features:

- Brightness dimming with one button at backside, 100%-50%-off;
- Available to DIY color of the handle and frame;
- Support to add the magnetic function.

### Diagram:

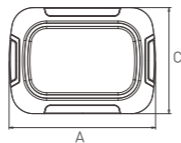

| Type I B |                                |               |                  |
|----------|--------------------------------|---------------|------------------|
| Power    | 10W                            | Charging Time | 4H               |
| Lumen    | 700lm                          | Working Time  | 3H               |
| Battery  | 3.7V 4000mAh 18650 Li-ion 2pcs | Material      | Plastic+PC       |
| USB      | 1M 5V 1A                       | Function      | DIM 100%-50%-off |
| CCT      | 3000K/4000K/6500K              | Dimension     | 175x40x125mm     |

Type I C

## LED Worklight

Replaceable Battery



Beam angle  
120°

IP54

SMD

CRI  
>80

-20°C  
+40°C

25000h



### Features:

- Brightness dimming with one button at backside, 100%-50%-off;
- Construction with replaceable battery works better for sustainable development ;
- Available to DIY color of the handle and frame.

### Diagram:

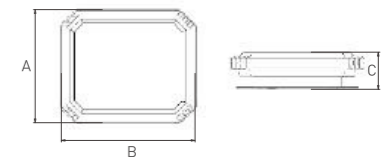

| Type I C |                                |               |                  |
|----------|--------------------------------|---------------|------------------|
| Power    | 10W                            | Charging Time | 4H               |
| Lumen    | 700lm                          | Working Time  | 3H               |
| Battery  | 3.7V 4000mAh 18650 Li-ion 2pcs | Material      | Plastic          |
| USB      | 1M 5V 1A                       | Function      | DIM 100%-50%-off |
| CCT      | 3000K/4000K/6500K              | Dimension     | 159x134x43mm     |

Type I D

# LED Worklight

Replaceable Battery



- 3** YEARS WARRANTY
- Beam angle 120°
- IP54
- SMD
- CRI >80
- 20°C +40°C
- PF >0.5
- 25000h



## Features:

- Brightness dimming with one button at backside, 100%-50%-off;
- Construction with replaceable battery works better for sustainable development ;
- Available to DIY color of the handle and frame;
- Support to add the magnetic function.
- **1M drop rest**

| Type I D |                                |               |                  |
|----------|--------------------------------|---------------|------------------|
| Power    | 10W                            | Charging Time | 5H               |
| Lumen    | 700lm                          | Working Time  | 5H               |
| Battery  | 3.7V 4000mAh 18650 Li-ion 2pcs | Material      | Plastic+PC       |
| USB      | 0.5M 5V 1A                     | Function      | DIM 100%-50%-off |
| CCT      | 3000K/4000K/6500K              | Dimension     | 157x109x38mm     |

Type II

# LED Worklight



- 3** YEARS WARRANTY
- Beam angle 120°
- IP54
- SMD
- CRI >80
- 20°C +40°C
- PF >0.5
- 25000h



## Features:

- One more handle for customer to take easier;
- Available to DIY color of the handle and frame;
- Brightness dimming with one button at backside, 100%-50%-SOS-off.

## Diagram:

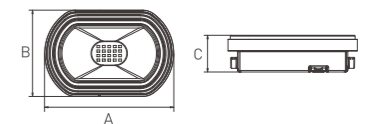

| Type II       |                                |                                |
|---------------|--------------------------------|--------------------------------|
| Power         | 10W                            | 20W                            |
| Battery       | 3.7V 3600mAh 18650 Li-ion 2pcs | 3.7V 7200mAh 18650 Li-ion 4pcs |
| USB Out       | 5V 1A                          | 5V 2A                          |
| Charging Time | 5H                             | 5H                             |
| Working Time  | 3H                             | 3H                             |
| CCT           | 3000/4000K/6500K               | 3000/4000K/6500K               |
| Material      | Plastic                        | Plastic                        |
| Function      | DIM 100%-50%-sos               | DIM 100%-50%-sos               |
| Dimension     | 165.6x47x110.6mm               | 175x125x53mm                   |

Frameless

# LED Worklight



- 
- 
- 
- 
- 
- 
- 
- 



### Diagram:

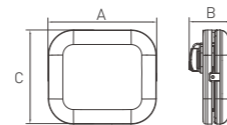

EMC 2.0 ERP 2.0 RoHS EMC LVD CE CB TÜV GS

### Features:

- Frameless design make the light more even and LED invisble in front side;
- Two sockets at backside support to use other electrical equipment;
- Brightness dimming with one button at backside, 100%-off-50% ;
- Portable LED worklight,1.5m meter power cable with plug.

| Frameless |                  |           |                  |
|-----------|------------------|-----------|------------------|
| Power     | 50W              | Material  | Aluminum+Plastic |
| Lumen     | 4000lm           | Function  | DIM 100%-50%-off |
| CCT       | 3000/4000K/6500K | Dimension | 237x205x110mm    |

Portable I

# LED Worklight



- 
- 
- 
- 
- 
- 
- 
- 



EMC 2.0 ERP 2.0 RoHS EMC LVD CE CB TÜV GS

### Features:

- Available for tough environment using with stronger aluminium body ;
- 1pcs socket at backside support to use other electrical equipment;
- Support to repair or replace the LED boards and driver inside,more friendly for the sustainable development;
- Portable LED worklight, 1.5m meter power cable with plug.

### Diagram:

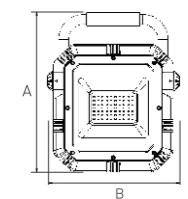

| Portable I    |                  |                  |
|---------------|------------------|------------------|
| Power         | 30W              | 50W              |
| Input Voltage | AC 220-240V      | AC 220-240V      |
| Efficiency    | 80lm/w           | 80lm/w           |
| CCT           | 3000/4000K/6500K | 3000/4000K/6500K |
| Material      | Aluminum+glass   | Aluminum+glass   |
| Function      | On/Off           | On/Off           |
| Dimension     | 355x295x70mm     | 355x295x70mm     |

# LED Worklight



- 3** YEARS WARRANTY
- Beam angle 120°
- IP54
- SMD
- CRI >80
- 30°C +50°C
- PF >0.9
- 25000h



### Features:

- Cable and Harness Design -Simple and easy to carry;
- Portable LED work lights,1.5meter power cable with plug;
- Die-casting aluminum housing & durable high quality powder paint;
- Brightness dimming with one button at backside, 100%-off-50%.

### Diagram:

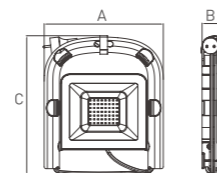

| Portable II |                  |           |                  |
|-------------|------------------|-----------|------------------|
| Power       | 50W              | Material  | Aluminum+glass   |
| Lumen       | 6000lm           | Function  | DIM 100%-50%-off |
| CCT         | 3000/4000K/6500K | Dimension | 314x48x365mm     |

# LED Worklight



- 3** YEARS WARRANTY
- Beam angle 120°
- IP54
- SMD
- CRI >70/80
- 20°C +40°C
- IK08
- 25000h

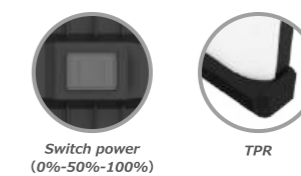

| WL04          |                   |
|---------------|-------------------|
| Power         | 50W (0%-50%-100%) |
| Input Voltage | AC 220-240V       |
| Efficiency    | 4000lm, 5400lm    |
| CCT           | 3000/5000K/6500K  |
| Material      | PC+Aluminum       |



WL03

## LED Worklight



Multiple color options



Handheld



Magnetic attraction



Stand



triangular bracket

### Features:

- This work light can meet different needs by replacing different brackets ;
- It is equipped with a magnetic suction function, hanging holes, and a clip. Additionally, it can also be adapted to a tripod bracket ;
- It can meet the requirements of a portable design ;
- Moreover, this work light is available in two versions: AC and DC. The AC version can meet the needs of scenarios that require high power and higher lighting requirements. The DC version comes with a built-in battery, eliminating the need for additional power supply, making it more flexible and portable to use.



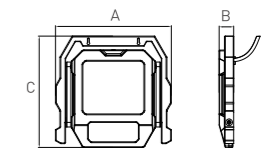



### Diagram:



| WL03          |                  |                            |                   |                   |
|---------------|------------------|----------------------------|-------------------|-------------------|
| Power         | 10W              | 20W                        | 30W               | 50W               |
| Input Voltage | DC               | AC 100-265V/220-240V or DC | 100-265V/220-240V | 100-265V/220-240V |
| Efficiency    | 100lm/w          | 100lm/w                    | 100lm/w           | 100lm/w           |
| CCT           | 3000/4000K/6500K | 3000/4000K/6500K           | 3000/4000K/6500K  | 3000/4000K/6500K  |
| Material      | PC+Aluminum      | PC+Aluminum                | PC+Aluminum       | PC+Aluminum       |
| Function      | On/Off           | On/Off                     | On/Off            | On/Off            |
| Dimension     |                  |                            |                   |                   |

# LED Worklight



-  3 YEARS WARRANTY
-  Beam angle 120°
-  IP65
-  SMD
-  CRI >70/80
-  -20°C +40°C
-  25000h



### Features:

- Aluminium housing and available to use in tough environment;
- Easy carry and adjustable bracket angle for storage;
- Portable LED worklight, 1.5m meter power cable with plug.

### Diagram:

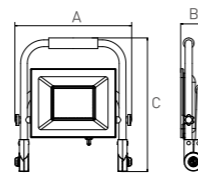

| XIII Serie    |                  |                  |                  |                  |
|---------------|------------------|------------------|------------------|------------------|
| Power         | 10W              | 20W              | 30W              | 50W              |
| Input Voltage | AC 220-240V      | AC 220-240V      | AC 220-240V      | AC 220-240V      |
| Efficiency    | 80lm/w           | 80lm/w           | 80lm/w           | 80lm/w           |
| CCT           | 3000/5000K/6500K | 3000/5000K/6500K | 3000/5000K/6500K | 3000/5000K/6500K |
| Material      | Aluminum+glass   | Aluminum+glass   | Aluminum+glass   | Aluminum+glass   |
| Function      | On/Off           | On/Off           | On/Off           | On/Off           |
| Dimension     | 178x52.5x233mm   | 213x53.3x255.2mm | 225x52.2x265mm   | 262x57x300mm     |

# LED Worklight



-  3 YEARS WARRANTY
-  Beam angle 120°
-  IP65
-  SMD
-  CRI >70/80
-  -20°C +40°C
-  25000h



### Features:

- Aluminium housing and available to use in tough environment;
- Easy carry and adjustable bracket angle for storage;
- Portable LED worklight, 1.5m meter power cable with plug.

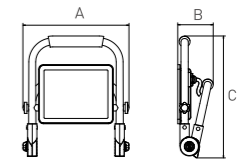

### Diagram:



| XVII Serie    |                  |                  |                  |                  |
|---------------|------------------|------------------|------------------|------------------|
| Power         | 10W              | 15W              | 20W              | 30W              |
| Input Voltage | AC 220-240V      | AC 220-240V      | AC 220-240V      | AC 220-240V      |
| Efficiency    | 80lm/w           | 80lm/w           | 80lm/w           | 80lm/w           |
| CCT           | 3000/5000K/6500K | 3000/5000K/6500K | 3000/5000K/6500K | 3000/5000K/6500K |
| Material      | Aluminum+glass   | Aluminum+glass   | Aluminum+glass   | Aluminum+glass   |
| Function      | On/Off           | On/Off           | On/Off           | On/Off           |
| Dimension     | 200x80.6x259mm   | 200x80.6x259mm   | 233x77.9x268mm   | 262x80.2x303mm   |

# LED Worklight



-  3 YEARS WARRANTY
-  Beam angle 120°
-  IP65
-  SMD
-  CRI >70/80
-  -30°C +50°C
-  25000h



### Features:

- Aluminium housing and available to use in tough environment;
- Easy carry with handle on the top;
- Portable LED worklight, 1.5m meter power cable with plug.

### Diagram:

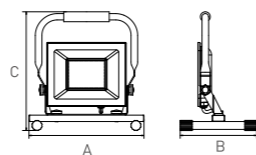

| XIII Serie    |                   |                   |                   |                   |
|---------------|-------------------|-------------------|-------------------|-------------------|
| Power         | 10W               | 20W               | 30W               | 50W               |
| Input Voltage | AC 220-240V       | AC 220-240V       | AC 220-240V       | AC 220-240V       |
| Efficiency    | 80lm/w            | 80lm/w            | 80lm/w            | 80lm/w            |
| CCT           | 3000K/5000K/6500K | 3000K/5000K/6500K | 3000K/5000K/6500K | 3000K/5000K/6500K |
| Material      | Aluminum+glass    | Aluminum+glass    | Aluminum+glass    | Aluminum+glass    |
| Function      | On/Off            | On/Off            | On/Off            | On/Off            |
| Dimension     | 166x185x216mm     | 218x185x239.5mm   | 243x185x250.9mm   | 278x185x287.3mm   |

# LED Worklight



-  3 YEARS WARRANTY
-  Beam angle 120°
-  IP65
-  SMD
-  CRI >70/80
-  -30°C +50°C
-  25000h



### Features:

- Aluminium housing and available to use in tough environment;
- Easy carry with handle on the top;
- Portable LED worklight, 1.5m meter power cable with plug.

### Diagram:

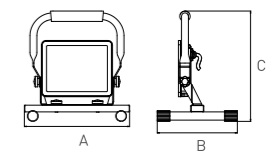

| XVII Serie    |                   |                   |                   |                   |
|---------------|-------------------|-------------------|-------------------|-------------------|
| Power         | 10W               | 15W               | 20W               | 30W               |
| Input Voltage | AC 220-240V       | AC 220-240V       | AC 220-240V       | AC 220-240V       |
| Efficiency    | 80lm/w            | 80lm/w            | 80lm/w            | 80lm/w            |
| CCT           | 3000K/5000K/6500K | 3000K/5000K/6500K | 3000K/5000K/6500K | 3000K/5000K/6500K |
| Material      | Aluminum+glass    | Aluminum+glass    | Aluminum+glass    | Aluminum+glass    |
| Function      | On/Off            | On/Off            | On/Off            | On/Off            |
| Dimension     | 218x185x234mm     | 218x185x234mm     | 234x185x255mm     | 278x185x287.3mm   |

Tripod Work Light XIII series

## LED Worklight



### Features:

- Aluminium housing and available to use in tough environment;
- Easy carry with tripod;
- Portable LED worklight, 1.5 meter power cable with plug.

### Diagram:

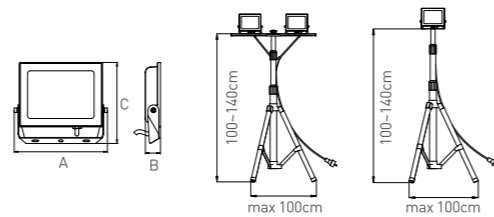

| XIII Serie           |                   |             |     |                 |                |
|----------------------|-------------------|-------------|-----|-----------------|----------------|
| Power                | 10/20/30/50W      | Power       | PF  | Lumen           | Dimension      |
| <b>Input Voltage</b> | AC 220-240V       | 10W / 10Wx2 | 0.5 | 800lm/800lmx2   | 126.5x28x114mm |
| <b>CCT</b>           | 3000K/5000K/6500K | 20W / 20Wx2 | 0.5 | 1600lm/1600lmx2 | 164x29x139mm   |
| <b>Material</b>      | Aluminum+glass    | 30W / 30Wx2 | 0.9 | 2400lm/2400lmx2 | 174x29x151mm   |
| <b>Holder</b>        | 1.1/1.4m          | 50W / 50Wx2 | 0.9 | 4000lm/4000lmx2 | 216x33x189mm   |

Tripod Work Light XVII series

## LED Worklight



### Features:

- Cable and Harness Design -Simple and easy to carry ;
- Portable LED work lights, 1.5 meter power cable with plug ;
- Die-casting aluminum housing & durable high quality powder paint ;
- High quality LED chips, color temperature: 3000K to 6500K.

### Diagram:

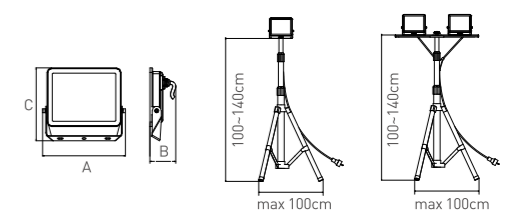

| XVII Serie           |                   |             |     |        |                    |
|----------------------|-------------------|-------------|-----|--------|--------------------|
| Power                | 10/15/20/30W      | Power       | PF  | Lumen  | Dimension          |
| <b>Input Voltage</b> | AC 220-240V       | 10W / 10Wx2 | 0.5 | 800lm  | 150.5x57.3x136.8mm |
| <b>CCT</b>           | 3000K/5000K/6500K | 15W / 15Wx2 | 0.5 | 1200lm | 150.5x57.3x136.8mm |
| <b>Material</b>      | Aluminum+glass    | 20W / 20Wx2 | 0.5 | 1600lm | 183.3x57.3x161.4mm |
| <b>Holder</b>        | 1.1/1.4m          | 30W / 30Wx2 | 0.9 | 2400lm | 213.5x57.3x185.1mm |

Tripod Work Light

## LED Worklight

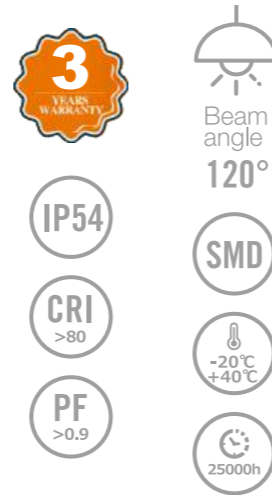

### Features:

- Unique design with three lighting diffusers;
- Adjustable lighting angle for the the two light diffuser asdie;
- Built-in carry Handle, users can take and use without the tripod;
- One button at backside to make on/ off function;
- Portable LED worklight,1.5m meter power cable with plug.
- **With Battery Version**

### Diagram:

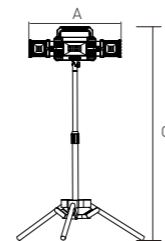

|         |                   |             |                 |
|---------|-------------------|-------------|-----------------|
| Power   | 30W+2x15W         | Material    | Aluminum+glass  |
| Voltage | AC 220-240V       | Tripod      | 1.2M            |
| Lumen   | 4800lm            | Dimension   | 780x78x1450mmmm |
| CCT     | 3000K/4000K/6500K | Power cable | 1.5M            |

Tripod Work Light

## LED Worklight



### Features:

- Unique design with three lighting diffusers;
- Adjustable lighting angle for the the two light diffuser asdie;
- Built-in carry Handle, users can take and use without the tripod;
- Portable LED worklight,1.5m meter power cable with plug.

### Diagram:



|         |                   |             |                |
|---------|-------------------|-------------|----------------|
| Power   | 20W               | Material    | Steel+PC       |
| Voltage | AC 220-240V       | Tripod      | 1.2M           |
| Lumen   | 2100lm            | Dimension   | 0.83mx1.2m MAX |
| CCT     | 3000K/4000K/6500K | Power cable | 1.5M           |

# LED Bulb



**TB03-T80**

Power: 36W  
CRI: >80  
PF: ≥0.5  
Input: 220-240V  
Base: E27/E40



**TB03-T100**

Power: 48W  
CRI: >80  
PF: ≥0.5  
Input: 220-240V  
Base: E27/E40



**TB03-T120**

Power: 65W  
CRI: >80  
PF: ≥0.5  
Input: 220-240V  
Base: E27/E40



**TB03-T130/140**

Power: 80/100W  
CRI: >80  
PF: ≥0.5  
Input: 220-240V  
Base: E27/E40



**TB02-T120**

Power: 65W  
CRI: >80  
PF: ≥0.5/0.9  
Input: 100-240V  
Base: E27/E40



**TB02-T130**

Power: 80W  
CRI: >80  
PF: ≥0.5/0.9  
Input: 100-240V  
Base: E27/E40



**TB02-T140**

Power: 100W  
CRI: >80  
PF: ≥0.5/0.9  
Input: 100-240V  
Base: E27/E40



**TB02-T170**

Power: 150W  
CRI: >80  
PF: ≥0.5/0.9  
Input: 100-240V  
Base: E27/E40



**TB02-T190**

Power: 200W  
CRI: >80  
PF: ≥0.5/0.9  
Input: 100-240V  
Base: E27/E40



**T60**

Power: 10W  
CRI: >80  
PF: ≥0.5  
Input: 220-240V  
Base: E27



**T70**

Power: 15W  
CRI: >80  
PF: ≥0.5  
Input: 220-240V  
Base: E27



**T80**

Power: 18/20/22W  
CRI: >80  
PF: ≥0.5  
Input: 220-240V  
Base: E27/E26/B22/E40



**T100**

Power: 25/30/32W  
CRI: >80  
PF: ≥0.5  
Input: 220-240V  
Base: E27/E26/B22/E40



**T120**

Power: 36/40/42W  
CRI: >80  
PF: ≥0.5  
Input: 220-240V  
Base: E27/E26/B22/E40



**T140**

Power: 48/50W  
CRI: >80  
PF: ≥0.5  
Input: 220-240V  
Base: E27/E26/B22/E40



**T160**

Power: 60W  
CRI: >80  
PF: ≥0.5  
Input: 220-240V  
Base: E27/E26/B22/E40



**G95**

Power: 8.5/11/12/15W  
CRI: >80  
PF: ≥0.5  
Input: 220-240V  
Base: E27



**G120**

Power: 15/18/19/20/22/23.5W  
CRI: >80  
PF: ≥0.5  
Input: 220-240V  
Base: E27



**F150**

Power: 16W  
CRI: >80  
PF: ≥0.5  
Input: 220-240V  
Base: E27



**F200**

Power: 24W  
CRI: >80  
PF: ≥0.5  
Input: 220-240V  
Base: E27



**F250**

Power: 36W  
CRI: >80  
PF: ≥0.5  
Input: 220-240V  
Base: E27

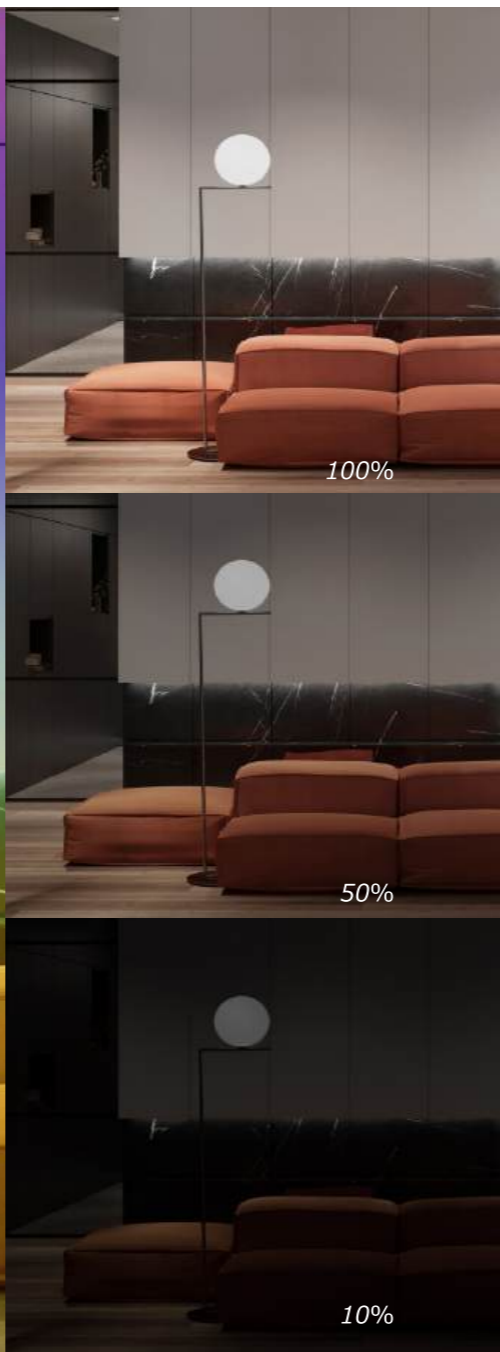

RGB

### Option

|                                    |  |                          |                              |                                |
|------------------------------------|--|--------------------------|------------------------------|--------------------------------|
| <p>100% 50% 10%<br/>Switch Dim</p> | <p>2700K 4000K 6500K<br/>Switch Tone</p> | <p>Light Sensor Bulb</p> | <p>Microwave Sensor Bulb</p> | <p>IR remote control +RGBW</p> |
|------------------------------------|--|--------------------------|------------------------------|--------------------------------|

Multiple functional options

## LED Bulb



|   |   |   |
|---|---|---|
| <p><b>C37</b><br/>Power: 1.6/2.9/3.5/4.5/5.5/6.5/7.5/8.5/10W<br/>Input: 220-240V<br/>CRI: &gt;80/90/97<br/>PF: ≥0.5<br/>Base: E14/E27/B15/B22</p> | <p><b>C37</b><br/>Tip<br/>Power: 1.6/2.9/3.5/4.5/5.5/6.5/7.5/8.5/10W<br/>Input: 220-240V<br/>CRI: &gt;80/90/97<br/>PF: ≥0.5<br/>Base: E14/E27/B15/B22</p> | <p><b>CF37</b><br/>Power: 1.6/2.9/3.5/4.5/5.5/6.5/7.5/8.5/10W<br/>Input: 220-240V<br/>CRI: &gt;80/90/97<br/>PF: ≥0.5<br/>Base: E14/E27/B15/B22</p>    |
| <p><b>T37</b><br/>Power: 8W<br/>Input: 220-240V<br/>CRI: &gt;80<br/>PF: ≥0.5<br/>Base: E14/E27/B15/B22</p>  | <p><b>T37</b><br/>Power: 8W<br/>Input: 220-240V<br/>CRI: &gt;80<br/>PF: ≥0.5<br/>Base: E14/E27/B15/B22</p>  | <p><b>P45/G45</b><br/>Power: 1.6/2.9/3.5/4.5/5.5/6.5/7.5/8.5/10W<br/>Input: 220-240V<br/>CRI: &gt;80/90/97<br/>PF: ≥0.5<br/>Base: E14/E27/B15/B22</p> |
| <p><b>P45/G45</b><br/>Power: 1.6/2.9/3.5/4.5/5.5/6.5/7.5/8.5/10W<br/>Input: 220-240V<br/>CRI: &gt;80/90/97<br/>PF: ≥0.5<br/>Base: E27</p>         | <p><b>A55</b><br/>Power: 2.9/4.5/5/7W<br/>Input: 220-240V<br/>CRI: &gt;80/90/97<br/>PF: ≥0.5<br/>Base: E27/B22</p>  | <p><b>A60</b><br/>Power: 5/7/9/9.5/11/13/15/17W<br/>Input: 220-240V<br/>CRI: &gt;80/90/97<br/>PF: ≥0.5<br/>Base: E27/B22</p>                          |
| <p><b>2500 LM</b><br/><b>A65</b><br/>Power: 15/17/18/20W<br/>Input: 220-240V<br/>CRI: &gt;80/90/97<br/>PF: ≥0.5<br/>Base: E27/B22</p>             | <p><b>A70</b><br/>Power: 15W<br/>Input: 220-240V<br/>CRI: &gt;80/90/97<br/>PF: ≥0.5<br/>Base: E27/B22</p>   | <p><b>A80</b><br/>Power: 18W<br/>Input: 220-240V<br/>CRI: &gt;80/90/97<br/>PF: ≥0.5<br/>Base: E27/B22</p>   |



**GU5.3**  
 Power: 3.5/4.5/5.5/6.5W  
 CRI: >80/90/97  
 PF: ≥0.5  
 Input: 220-240V  
 Base: GU5.3



**GU5.3**  
 Power: 3.5/4.5/5.5/6.5/7.5/8/9W  
 CRI: >80/90/97  
 PF: ≥0.5  
 Input: 220-240V  
 Base: GU5.3



**GU5.3**  
 Power: 3W/4W/5W  
 CRI: >80/90/97  
 PF: ≥0.5  
 Input: 220-240V  
 Base: GU5.3



**R39**  
 Power: 3.7/5W  
 CRI: >80  
 PF: ≥0.5  
 Input: 220-240V  
 Base: E14



**R50**  
 Power: 4.2/4.8/7W  
 CRI: >80  
 PF: ≥0.5  
 Input: 220-240V  
 Base: E14



**R63**  
 Power: 7/8.5/9W  
 CRI: >80  
 PF: ≥0.5  
 Input: 220-240V  
 Base: E27



**GU10**  
 Power: 3.5/4.5/5.5/6.5/8.5W  
 CRI: >80/90/97  
 PF: ≥0.5  
 Input: 220-240V  
 Base: GU10



**GU10**  
 Power: 3.5/4.5/5.5/6.5/7.5/8/9W  
 CRI: >80/90/97  
 PF: ≥0.5  
 Input: 220-240V  
 Base: GU10



**CLASS B**  
**GU10**  
 Power: 4W/6.5W  
 CRI: >80/90/97  
 PF: ≥0.5  
 Input: 220-240V  
 Base: GU10



**R80**  
 Power: 8.5/9.5/13W  
 CRI: >80  
 PF: ≥0.5  
 Input: 220-240V  
 Base: E27



**PAR20**  
 Power: 7W  
 CRI: >80  
 PF: ≥0.5  
 Input: 220-240V  
 Base: E27



**PAR30**  
 Power: 11W  
 CRI: >80  
 PF: ≥0.5  
 Input: 220-240V  
 Base: E27



**JDR**  
 Power: 4W/5W/6.5W  
 CRI: >80  
 PF: ≥0.5  
 Input: 220-240V  
 Base: E14



**JDR**  
 Power: 4W/5W/6.5W  
 CRI: >80  
 PF: ≥0.5  
 Input: 220-240V  
 Base: E14



**JDR**  
 Power: 4W/5W/6.5W  
 CRI: >80/90/97  
 PF: ≥0.5  
 Input: 220-240V  
 Base: E14



**PAR38**  
 Power: 14W  
 CRI: >80  
 PF: ≥0.5  
 Input: 220-240V  
 Base: E27



**JDR**  
 Power: 4W/5W/6.5W  
 CRI: >80  
 PF: ≥0.5  
 Input: 220-240V  
 Base: E27



**JDR**  
 Power: 4W/5W/6.5W  
 CRI: >80  
 PF: ≥0.5  
 Input: 220-240V  
 Base: E27



**JDR**  
 Power: 4W/5W/6.5W  
 CRI: >80/90/97  
 PF: ≥0.5  
 Input: 220-240V  
 Base: E27



**G9**  
Power: 2.5W  
CRI: >80/90/97  
PF: ≥0.5  
Input: 220-240V  
Base: G9



**G9**  
Power: 3W  
CRI: >80/90/97  
PF: ≥0.5  
Input: 220-240V  
Base: G9



**G9**  
Power: 2.5W  
CRI: >80  
PF: ≥0.5  
Input: 220-240V  
Base: G9



**G4**  
Power: 1W  
CRI: >80  
PF: ≥0.5  
Input: 12V AC/DC  
Base: G4



**G4**  
Power: 1.2W  
CRI: >80/90/97  
PF: ≥0.5  
Input: 12V AC/DC  
Base: G4



**T26**  
Power: 2.5W  
CRI: >80/90/97  
PF: ≥0.5  
Input: 220-240V  
Base: E14



**B35**  
Power: 2/4W  
Input: 220-240V  
CRI: >80  
PF: ≥0.5  
Base: E12/E14



**C37**  
Tip  
Power: 2/4W  
Input: 220-240V  
CRI: >80  
PF: ≥0.5  
Base: E12/E14



**P45**  
Power: 2/4W  
Input: 220-240V  
CRI: >80  
PF: ≥0.5  
Base: E12/E14



**P45**  
Power: 2/4W  
Input: 220-240V  
CRI: >80  
PF: ≥0.5  
Base: E26/E27/B22



**A60**  
Power: 5/6W  
Input: 220-240V  
CRI: >80  
PF: ≥0.5  
Base: E26/E27/B22



**A70**  
Power: 8/10W  
Input: 220-240V  
CRI: >80  
PF: ≥0.5  
Base: E26/E27/B22



G4/9



GX53

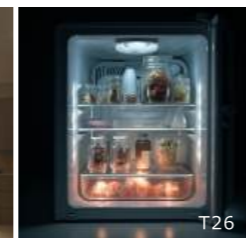

T26



**GX53-1**  
Power: 5/7/8/9W  
CRI: >80  
PF: ≥0.5  
Input: 220-240V  
Dimension: Ø74x26mm  
Base: GX53



**GX53-2**  
Power: 10/12W  
CRI: >80  
PF: ≥0.5  
Input: 220-240V  
Dimension: Ø74x28mm  
Base: GX53



**ST26**  
Power: 2W  
Input: 220-240V  
CRI: >80  
PF: ≥0.5  
Base: E12/E14



**T26**  
Power: 2W  
Input: 220-240V  
CRI: >80  
PF: ≥0.5  
Base: E12/E14



**T32**  
Power: 2/4/5W  
Input: 220-240V  
CRI: >80  
PF: ≥0.5  
Base: E12/E14



**G80**  
Power: 4/6W  
CRI: >80  
PF: ≥0.5  
Input: 220-240V  
Base: E27/E26EB22



**G95**  
Power: 4/6W  
CRI: >80  
PF: ≥0.5  
Input: 220-240V  
Base: E27/E26EB22



**G120**  
Power: 4/6W  
CRI: >80  
PF: ≥0.5  
Input: 220-240V  
Base: E27/E26EB22



**ST48**  
Power: 2/4W  
CRI: >80  
PF: ≥0.5  
Input: 220-240V  
Base: E27/E26EB22



**ST58**  
Power: 4W  
CRI: >80  
PF: ≥0.5  
Input: 220-240V  
Base: E27/E26EB22



**ST64**  
Power: 4/5/6W  
CRI: >80  
PF: ≥0.5  
Input: 220-240V  
Base: E27/E26EB22



## ACCESSORIES

### Mounting Bracket



Ø50 Mounting Bracket



Mounting Bracket



Mounting Bracket



Mounting Bracket

### Lamp Base



NEMA 3PIN Lamp Base



NEMA 7PIN Golden Lamp Base



NEMA Cap

### Photocell



NEMA 3PIN Photocell



Photocell

### PIR Sensor



3PIN Microwave PIR Sensor



3PIN Infrared PIR Sensor



Zhaga PIR Sensor



Zhaga Microwave PIR Sensor



Zhaga Infrared PIR Sensor

### Sensor Base



Zhaga Sensor Base



Zhaga Sensor Cap

### Lamp Lanyard



Lamp Lanyard Length 400mm



Lamp Bracelet Length 300mm



Remote Control

### Emergency Pack



Emergency Battery Pack



Emergency Power



Emergency Battery Pack

### Reflector



PC Reflector



Aluminum Reflector

### Ground Plug



Ground Plug and Screw

### Three-Way Waterproof Connector

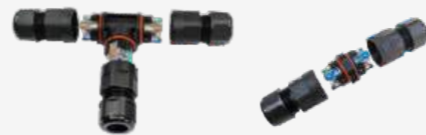

Ground Plug and Screw

### Surge Protector



Surge Protector  
(total length 370mm)



Surge Protector  
(total length 370mm)  
BIS 800+800V



Surge Protector  
(total length 600mm)

### Terminal Block



### Infrared Sensor



Motion Sensor

### DIP Switch CCT



Adjust Color Temperature  
and Power

### Top05 Matching



Connect Two Tp05

### BL04 Connecting Wire



Connect Two BL04

### Infrared Remote



Infrared Remote-controlled  
Lighting with Multi-colour  
Change Function



Infrared Remote  
Control Ceiling  
Light



Microwave PIR  
Sensor Remote



Regulating Solar  
Floodlights, Solar  
Street Lights, etc.



Adjusting Power for  
Solar Street Lights, etc.